

bw-d01

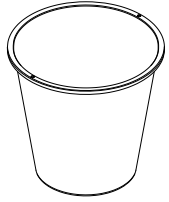

barrel

h 720 mm x d 750 mm

x 1

18.99 €

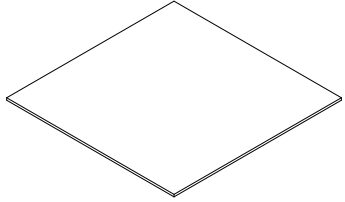

wooden boards

1400 × 1400 × 19 mm

900 × 900 × 19 mm

200 × 100 × 19 mm

x 1

x 1

x 4

43.00 €

17.78 €

1.76 €

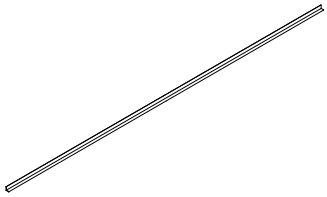

L profile

2000 × 20 × 18 mm

x 4

7.75 €



spax screw

m4 × 30 / m4 × 15

16 x / 24 x

2.59 €, 20 stk. / 5.29€, 50 stk.

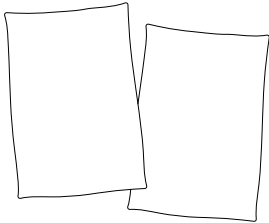

sand bag

25 kg

2 x

4,95

bw-d01

1 screw the medium board centrally onto the large board

-

wooden board 1400 × 1400 × 19 mm
wooden board 900 × 900 × 19 mm
spax screw m4 × 30

screwdriver
countersink
drill
bit

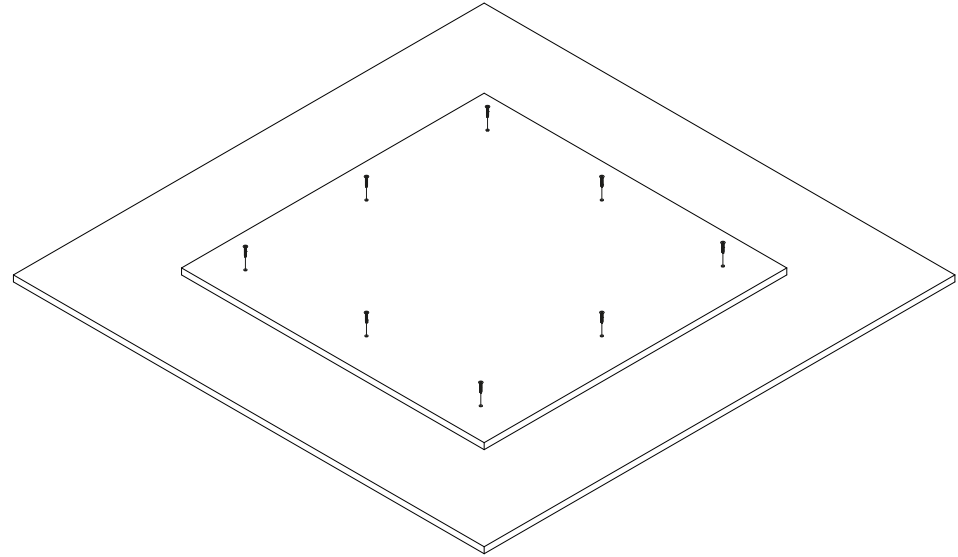

2 screw the four small boards onto the medium board using the indicated dimensions

-

wooden boards 200 × 100 × 19 mm

spax screws m4 × 30

screwdriver
countersink
drill
bit

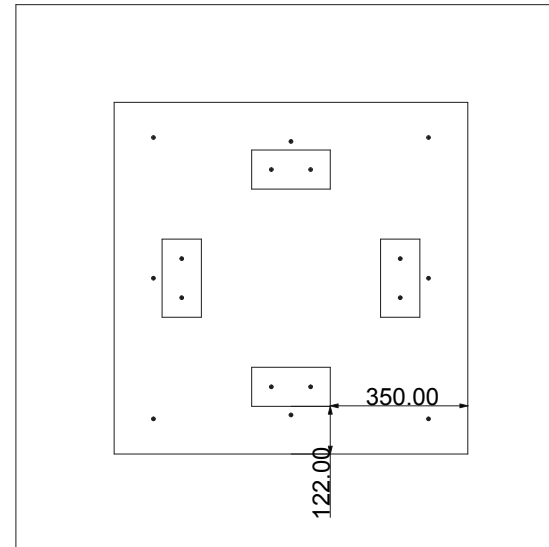

bw-d01

3 cut the ends of the profiles at a 45 degree angle and screw them to the bottom of the large board

-

L profiles
spax screws m4 × 15 mm

screwdriver
countersink
drill
bit
saw

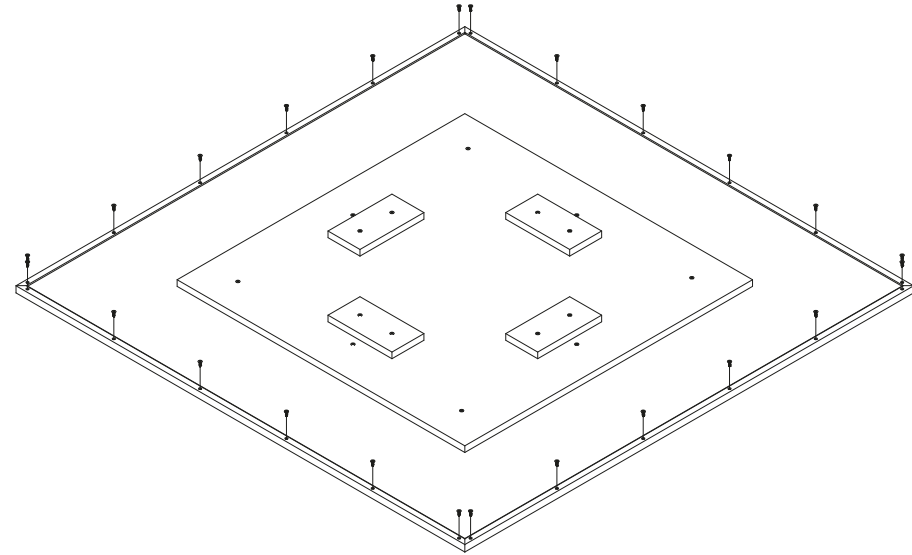

4 place the two 25 kg sand bags in the barrel

-

barrel
sand bags

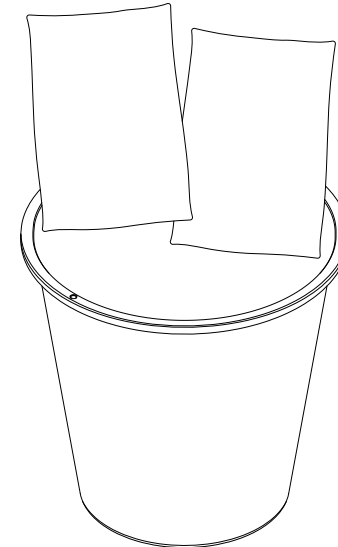

5 place the table top on the barrel and screw it down if necessary

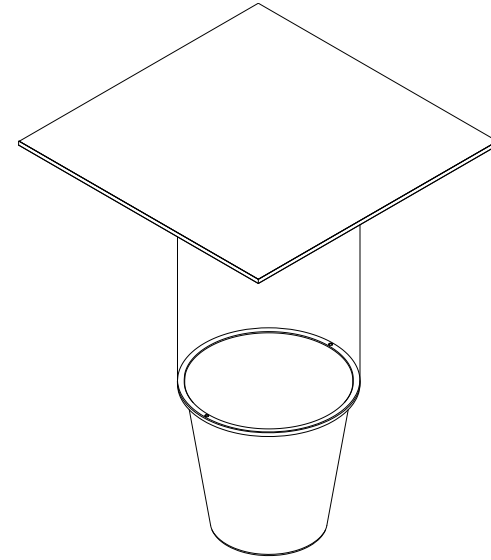

6 sit down, invite friends for dinner or start working on the next project

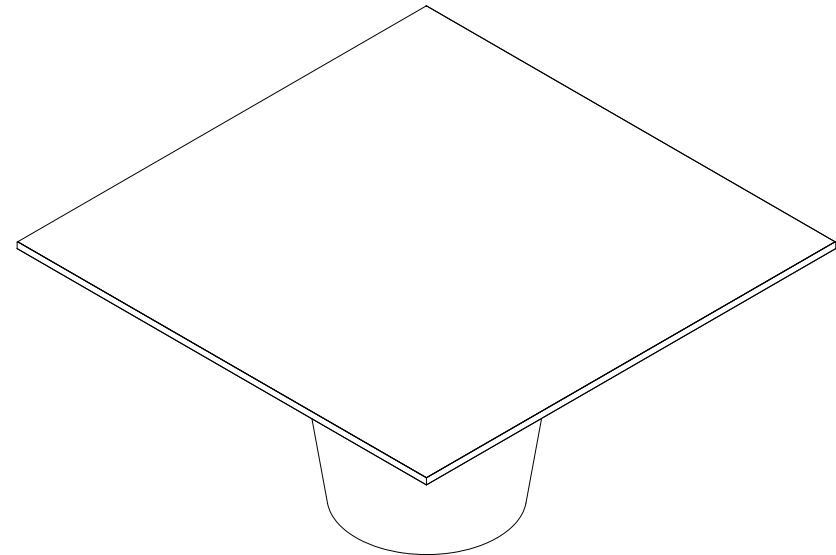

bw-d01 is a multifunctional table that can be used for working or for social gatherings with up to eight people.

all you need is a cordless screwdriver, a saw, a scale, a cross bit, a countersink and a m4 drill bit. all the parts you need are listed in the parts list. the project will cost you about 100 bucks and will take about an hour to build.

misuse defines a new approach of how furniture can be designed sustainably and made available democratically today. this approach is together with the criticism of predominant industrial patterns manifested in the objects themselves.

what? functional and appealing objects for the private context that can be built by oneself, using only existing products as well as semi-finished and finished parts, which can be bought in the local hardware store for little money.

how? any object can easily be built by using the open source misuse manuals. no special knowledge or professional tools are needed for the construction. in the manuals you will find a list of all necessary parts and their prices, a list of required tools, the building instructions themselves and an approximate indication of time needed.

why? by using already existing products as well as semi-finished and finished parts from the hardware store, the objects do not consume any new resources. in this way, the objects save the environment, set a statement against industrial consumption and make good design democratically accessible to everyone. sidefact: they are fun to build!